

4.1 Interior Anchoring

CETRIS® boards can be fixed to the structures using screws, staples or nails. All types of fastening elements must be treated with an anti-corrosion agent; use of screws to fix plasterboard is not recommended. When using regular screws the screw holes should be pre-drilled to 1.2 multiple of the screw used. It is also recommended to prepare the countersinking for the sunken screw heads. For professional screwing it is recommended to use pneumatic or electrical screwdrivers with regulated revolutions.

The principles stated in this chapter (screwing to timber, sheet metal, stapling, nailing) also apply to exterior anchoring in cases where the board forms a base for a contact insulating system, or a composite roof system.

4.1.1 Screwing to Timber

For correct fixation of CETRIS® boards to constructions it is necessary to keep the maximum spacing of the load-bearing construction and the fixation elements. The best fastening element for fixation of CETRIS® boards is a self-tapping screw with double thread, hardened tip and sunken head with blades for countersinking. This type of screw may be supplied as an auxiliary material with CETRIS® label, diameter 4.2 mm, lengths 35, 45, 55 mm for connecting of two CETRIS® boards in the floating floor system or for board fixation to horizontal and vertical timber constructions (floors, partition walls, ceiling panels, etc.). For anchoring purposes the screw should penetrate to the wooden construction with at least 2/3 of its length. For fixation of floor boards, a screw of the length exceeding the board thickness by 20 mm will suffice.

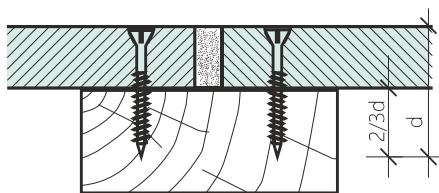

CETRIS self-tapping screw to timber

4.1.2 Screwing to Sheet Metal

For fixation of CETRIS® boards to sheet metal profiles there is the self-tapping screw, CETRIS® 4.2 × 25 mm (this screw is threaded up to the head), or screws 4.2 × 35, 45, 55 mm (thread up to about 2/3 of the shank length). The most often used load-bearing constructions include zinc-coated CW and UW profiles. Horizontal UW profiles are anchored via sound absorbing inserts to the ceiling (floor) construction. Vertical CW profiles are inserted in the UW profiles, about 15 mm short of the room height. The CETRIS® board for wall cladding is only fixed to the vertical profiles (stands – CW). When anchoring to sheet metal profiles the screw should protrude by at least 10 mm through the thickness of the board. It is recommended to pre-drill the CETRIS® board. At the contact point – of the vertical joint and the vertical CW profile – first anchor the CETRIS® board closer to the stand of the CW profile. In the case of the opposite procedure (anchoring to the soft part of the CW profile) there is the risk of deformation of the profile and subsequently the cladding!

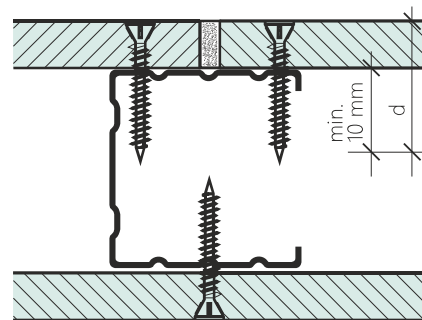

CETRIS self-tapping screw to sheet metal

A) Specification of resistance to the screw pulling out perpendicularly to the board plane:

Test method: ČSN EN 320
 Screw type: CETRIS 4,2 x 35 mm
 (pre-drilled hole in the board with a diameter of 3.5 mm)

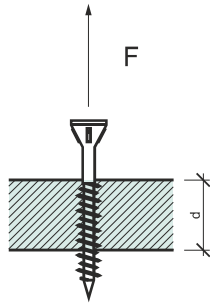

Board thickness d	Resistance
8 mm	597 N
10 mm	788 N
12 mm	1305 N

Interior wall – no fire resistance requirement (or exterior cladding under contact thermal insulation systems)

Board thickness (mm)	Screw spacing a (mm)	Beam spacing b (mm)	Distance of screws from vertical edge c_1 (mm)	Distance of screws from horizontal edge c_2 (mm)
8	< 200	< 420	> 25 < 50	> 50 < 100
10	< 250	< 500		
12, 14	< 250	< 625		
16, 18, 20	< 300	< 670		
22, 24, 26, 28, 30	< 350			
32, 34, 36, 38, 40	< 400			

Interior ceiling – no fire resistance requirement (or exterior cladding under contact thermal insulation systems)

Board thickness (mm)	Screw spacing a (mm)	Beam spacing b (mm)	Distance of screws from vertical edge c_1 (mm)	Distance of screws from horizontal edge c_2 (mm)
8	< 200	< 420	> 25 < 50	> 50 < 100
10	< 250	< 500		
12	< 300	< 625		

Interior ceiling – with fire resistance requirement (or exterior cladding under thermal insulation systems)

Board thickness (mm)	Screw spacing a (mm)	Beam spacing b (mm)	Distance of screws from vertical edge c_1 (mm)	Distance of screws from horizontal edge c_2 (mm)
12	< 200	< 420	> 25 < 50	> 50 < 100

B) Specification of resistance to the screw pulling out parallel to the board plane:

Test method: ČSN EN 320
 Screw type: CETRIS 4,2 x 35 mm
 (pre-drilled hole in the board with a diameter of 3.5 mm)

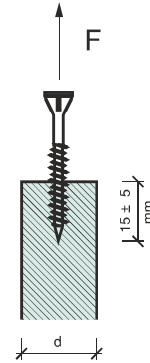

Board thickness d	Resistance
22 mm	1039 N

Note: informative values.

Interior wall – with fire resistance requirement (or exterior cladding under thermal insulation systems)

Board thickness (mm)	Screw spacing a (mm)	Beam spacing b (mm)	Distance of screws from vertical edge c_1 (mm)	Distance of screws from horizontal edge c_2 (mm)
10, 12, 14, 16, 18	< 200	< 625	> 25 < 50	> 50 < 100

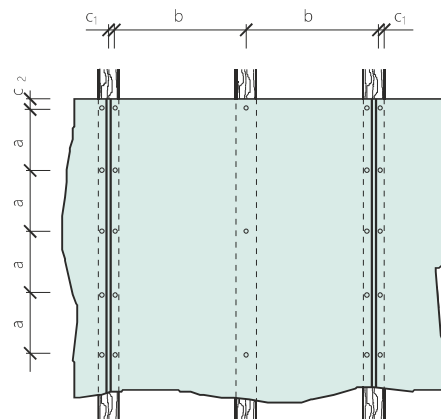

Flooring constructions – for details, see Chapters 6.6 and 6.7

Board thickness (mm)	Screw spacing a (mm)	Beam spacing b (mm)	Distance of screws from vertical edge c_1 (mm)	Distance of screws from horizontal edge c_2 (mm)
12 (ZOCET, POLYCET floating floors)	Upper layer pre-drilled, max. 300 mm		>25 <50	50
16,18,20,22,24 CETRIS PD (PDB)	< 300	Pursuant to load tables		
26,28,30,32,34, 36,38 CETRIS PD (PDB)	< 400			

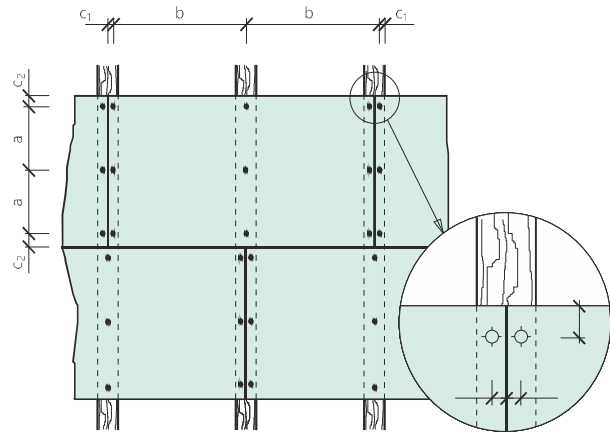

4.1.3 Stapling

Pneumatic staplers are used for fixation of the cement bonded particleboards (static load-bearing and non-load-bearing) to a wooden base (beam, column, KV prism, and the like). Various models are available according to the type and thickness of the board. The models differ in the type of staple used (wire diameter) and size of the body for higher impact force.

Staple types KG 700 CNK geh / DIN 1052 /, wire diameter 1.53 mm
 KG 700 CDNK geh, for joint / board on board /
 KG 745 CNK geh for board of max. th. 10 mm to wood.
 KG 722 CDNK geh for joining of the board to a board of thickness 12x12 mm.
 KG 718 CDNK geh for joining of the board to a board of thickness 10x12 mm.
 Recommended staplers: PN 755 XI/Kontakt, PN 755 XI/Automat

- staple length up to 55 mm
- the Automat version has a rate of up to 300 staples /min

4.1.4 Nailing

Nailing may be used to anchor CETRIS® cement bonded particleboards of thickness 8 - 22 mm. Recommended board nailing principles:

- nail diameter $d_n = 2,1-2,5$ mm.
- minimum nail length = board thickness + 30 mm (min)
- nails must not be embedded lower than 2 mm.

HD 7900 CNK geh /DIN 1052/, wire diameter 1.83 mm
 SD 9100 CNK geh /DIN 1052/, wire diameter 2.00 mm
 Stapler PN 9180 XII/ Kontakt

- staple length up to 75(80) mm
- model XII with high impact force

Recommended board stapling principles

- minimum staple distance from board edge 20 mm
- minimum staple spacing 30 mm (36 mm for the HD7900 staples and SD9100), max. 75 mm (around the perimeter), max. 150 mm inside the board area
- staples obliquely to the board edge, at least under an angle of 30°

Recommended staple length (HD 7900 CNK geh, SD 9100 CNK geh)

Board thickness (mm)	12	14	16	18	20	22
Staple length (mm)	45	50	60	70	70	70

- nailer types Duo Fast CNP 50.1, CNP 65.1, Haubold RNC 50M, RNC 65 S/WII, recommended working pressure 6 - 8 bar (max. 8 bar).
- minimum nail spacing in boards on a wooden base, the minimum nail spacing from the non-stressed edge of the board is 5. d_n , the minimum nail spacing from the stressed edge of the board is 7. d_n .
- the mutual spacing of the nails in the boards is minimum 20. d_n , maximum 75 mm (edge support), 150 mm (inner reinforcements).



4.2 Exterior Anchoring - Screws (Fasteners)

Façade cladding with visible horizontal and vertical joints – VARIO system – for details see Chapter 7.1.3.1.

CETRIS® boards are fixed in the VARIO system (façades, skirting lining, roof overhangs, suspended ceilings...) with stainless steel or galvanized screws with semi-circular or hexagonal heads and compressive water-tight washers. These washers are treated on the bottom side with vulcanized elastomer EPDM for water-tight and flexible material connection. The screw type also depends on the base type – the load-bearing grid applied. It is also possible to use rivets to fix the boards to galvanized (aluminium) constructions. (See Chapter 7.1.6.2)

Pre-drilling of the boards (applies to a screw / rivet diameter of up to 5 mm). CETRIS® boards must be pre-drilled:

- Diameter 8 mm for board lengths up to 1,600 mm
- Diameter 10 mm for board lengths over 1,600 mm

For position stabilisation at least one fixed point (with the diameter of 5 mm) is needed. Dilations between boards 5–10 mm.

VARIO anchoring table

Board thickness (mm)	Screw spacing a (mm)	Beam spacing b (mm)	Distance of screws from vertical edge c_1 (mm)			Distance of screws from horizontal edge c_2 (mm)
			Timber	Zinc	Aluminium	
8	< 400	< 420	>25 < 50	>30 < 50 >50 < 70 *	>50 < 70	>70 < 100
10	< 500	< 500				
12	< 500	< 625				
14	< 550	< 625				
16	< 550	< 700				

* Applies to the installation of the CETRIS® boards with horizontal dimension > 1,875 mm

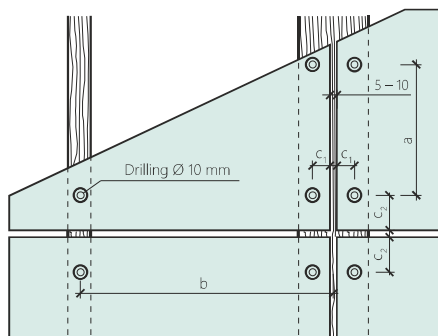

Façade cladding with overlapped joints – PLANK system – for details see Chapter 7.1.3.2.

CETRIS® boards in the PLANK system (overlapped) are fixed with galvanized screws or stainless steel screws with sunken heads.

Pre-drilling of the boards (applies to a screw diameter of up to 5 mm):

- outer – diameter of 8 mm
- inner – 1.2 times of the screw diameter

Note: The recommended maximum length of CETRIS® board for PLANK system equals triple the span of the auxiliary vertical profiles (laths) – i.e. for board thickness 10 mm is max. 1,500 and for board thickness 12 mm is 1,875 mm.

PLANK anchoring table

Board thickness (mm)	Screw spacing a (mm)	Support span b (mm)	Screw distance from vertical edge c_1 (mm)	Screw distance from horizontal edge c_2 (mm)	Maximum length of board (mm)
			Timber / Zinc coat / Aluminium		
8	< 400	< 420	>35 < 50	min. 40	1260
10	< 400	< 500			1500
12	< 350	< 625			1875
14	< 400	< 625			1875
16	< 400	< 700			2100

* Applies to the installation of the CETRIS® boards with horizontal dimension > 1,875 mm

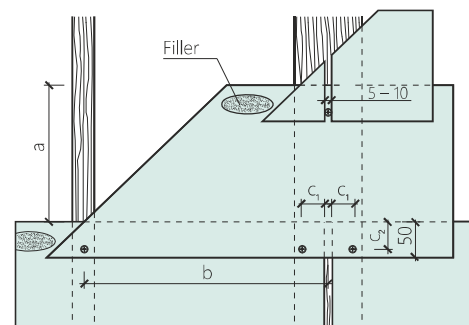

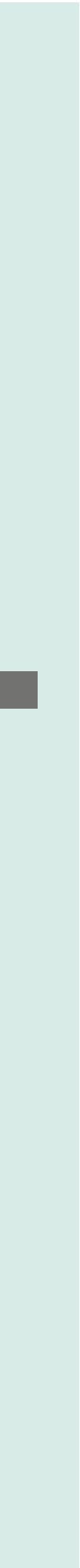

Surface Treatments of CETRIS[®] Cement Bonded Particleboards

Joint Filling with Permanently Elastic Fillers	5.1
Paints	5.2
Interior Plasters	5.3
Exterior Plasters	5.4
Ceramic Tiles for Interiors	5.5

Surface Treatments of CETRIS® Cement Bonded Particleboards

When applying surface treatments to the CETRIS® cement bonded particleboards, it is necessary to observe the following principles:

- All applied materials must be stable in an alkali environment
- Before application of paints, glues or plasters on CETRIS® boards the boards must be covered with a primer for absorptive surfaces
- The materials must be applied on the dry surfaces of the CETRIS® boards in compliance with the technological procedures required by the material manufacturers
- It is recommended to apply not hard materials but rather permanently elastic materials
- Dilation joints between boards may be covered with laths or filled with elastic filler (acrylic, polyurethane)
- Coating and sealing can be done after acclimatization of boards in installed condition

5.1 Joint Filling with Permanently Elastic Fillers

When using CETRIS® boards for walls, partition walls and ceiling cladding, the boards must be dilated – visible joints must be left with the minimum width of 5 mm. The joints may be covered with laths, an inserted wooden, plastic or sheet metal profile, or filled with permanently elastic filler. The recommended fillers are the ones based on acrylic resins or polyurethanes. Silicon fillers may be applied to compact materials with acid pH, which is not the case of CETRIS® board. Where silicon filler must be used, the contact surfaces must be treated with a primer. The main principle for correct function of the dilatation joints is elimination of three-sided adhesion in the joint, which causes

uneven stress on the elastic filling and subsequently its tearing off the joint sides. This may be prevented by insertion of a slide insert – a polyethylene tape or string. The result is adhesion of the elastic matter on the opposite sides (edges of CETRIS® boards) only and even stress on the fill – the “chewing gum effect”. Ensure that the string is 25 % larger than the width of the joint. Press it in to a depth, which corresponds to the chosen depth of the sealed end. To ensure a constant depth, it is good to use, for instance, a peg with graduation. The surfaces neighbouring the joint can be protected with paper tape. Remove the tape immediately upon completion of the joint-filling process.



Fillers recommended for joint filling

Description	Properties	Application	Procedure	Manufacturer
Acrylic elastic filler S-T 5 Single-component sealing joint filler. Creates a permanent firm elastic joint.	High adhesion, coverable with acrylic and dispersion paints. After hardening resistant to weather effects including UV radiation. Maximum permissible deformation 20 %.	Filling joints in peripheral coats of cement bonded particleboards CETRIS® with joint widths of 5 – 40 mm.	The surface must be clean, dry, firm, without grease and oils. It is recommended to treat the base with a primer – diluted filler S-T 5 (diluted in water in the ratio 1:3).	DEN BRAVEN
Soudaflex 14 LM Single-component elastic low-module filler on polyurethane basis.	Permanently elastic after maturation, maximum permitted deformation 25 %. When covered with regular oxidation paints the paint drying process may be delayed.	Joint filling with high contact movement. Joint width 5 – 30 mm.	The surface must be clean, dry, firm, free of grease and oil. It is recommended to treat the base with a primer – Primer 100.	SODAL

Description	Properties	Application	Procedure	Manufacturer
MAPEFLEX Ac4 - Single-component joint filling materials on acrylic resin basis.	Water- and air-tight permanently elastic joint filler.	Joint fill with maximum movement possible 15 – 20 %. Joint width 5 – 30 mm.	The surface must be clean, dry, firm, free of grease and oil.	MAPEI
BOTACT A4 - Single-component acrylic filler.	Weather resistant, high ductility, can be covered with paint.	For joint sealing and construction board connection.	The surface must be clean, firm, dust-free and without oils and grease.	BOTAMENT
SCHÖNOX S 20 - Permanently elastic single-component joint filler on MS polymer basis.	High adhesion, resistant to water, weather and UV radiation, coverable with acrylic and dispersion paints. Maximum permitted deformation 25 %.	Filling joints in peripheral coats, balconies, dilatation joints between construction slabs and in ceramic paving. For joints of width 5 – 20 mm.	The surface must be firm, dry, without dust, grease and other impurities. It is recommended to treat the base with Casco Primer 12.	SCHÖNOX
Henkel – Building acrylic Dispersion sealing filler	Does not contain solvents, coverable with paint, odourless, resistant to UV radiation.	Sealing of joints with a width of 5 – 30 mm.	The surface must be clean, dry, firm, without dust, grease and oil. It is recommended to moisten the base before application.	HENKEL
Dexaflam - R - Single-component elastic filler. FIRE PROTECTION APPLICATIONS	Permanently elastic after maturation, maximum permitted deformation 15 %.	Joint filling between boards, fire resistance. Joint width 5 – 20 mm.	The surface must be clean, dry, firm, free of grease and oil. It is recommended to treat the edges with a primer – diluted filler Dexaflam – R.	TORA
Den Braven - Single-component acrylic fire protection filler.	Single-component sealing filler on acrylic dispersion basis. Slightly foams at temperatures above +120°C and retards propagation of fire. Retards fire, slows down combustion.	Fire protection filler - filling of interior CETRIS® board joints.	The surface must be clean, dry, firm, without free dust particles, grease and oil. For joints of width up to 10 mm the ratio of 1:1 applies with a minimum depth and width of 5 mm.	DEN BRAVEN
Den Braven - Silicone fire protection filler	Single-component neutral silicone filler. Hardens by vulcanization at atmospheric humidity and creates a permanent firm elastic joint that prevents the entry of smoke and fire.	Fire protection filler - filling of joints between the CETRIS® boards that is resistant to UV, water, moisture.		DEN BRAVEN
SIKA Firesil - permanently elastic 1-component silicone based filler. FIRE PROTECTION APPLICATIONS	High-adhesion, fire-resistant, water-resistant.	Filling joints between boards, maximum joint width of 15 mm.	The surface must be clean, firm, dust-free and without oil and grease.	SIKA

5.2 Paints

Painting a CETRIS® board is the most frequently used surface finish. When applying surface treatments to the CETRIS® cement bonded particleboards, it is necessary to respect their composition. It mainly necessary to respect the fact that the CETRIS® BASIC cement bonded particleboard is construction material with permissible minor defects in the face and backside. The characteristics of the surface of the 1st Class Quality CETRIS® cement bonded particleboards is given in Chapter 1.5 of this publication. Parameters of the dispatched boards. The back side of the boards (digitally marked by the manufacturer) has more porous surface and may have a larger number of minor defects as compared to the face.

Recommended paint coat application procedure:

- before application of the paint coat, it is necessary to remove all visible wooden particles and bark from the surface (remove them with a palette knife). These areas must be sealed with two-component polyester filler for exterior use. Minor unevenness in the surface is also sealed in the same manner (depressions, grooves). The filler must be sanded. Coating may be done only 18 hours after sanding.
 - the CETRIS® board surfaces must be dry, clean, free of grease and oils. Dust and other impurities from the working process may remain on the board, especially on its edges (cutting, milling, etc.). For this reason, the edges must be sanded with sand paper of grain 80 before application of the coat and rid of dust impurities.
- A primer must be applied to the board (stabilization of the surface, reduction of its absorptive power, unification of the base). A primer must be applied to all the surfaces—face, underside and edges!
 - The top coats recommended by their manufacturers for a cement base must be used
 - The product composition must be unified and the prescribed technological procedure must be followed (especially the application method, technological breaks)
 - The paints must contain pigments stable in an alkali environment. Unstable pigments may lead to discolouration. To ensure an even surface finish, the reverse side must also be provided with protective primer. For aesthetic reasons, CETRIS® boards with chamfered edges may be used. For invisible joints, a full-area trowel-on system must be used, see below. Note: For old paint renewals, it is necessary to consider the condition of the existing paint and type of paint used (composition). The surface must be roughened and cleaned before re-painting. The covering paint must have the same composition as the initial paint.

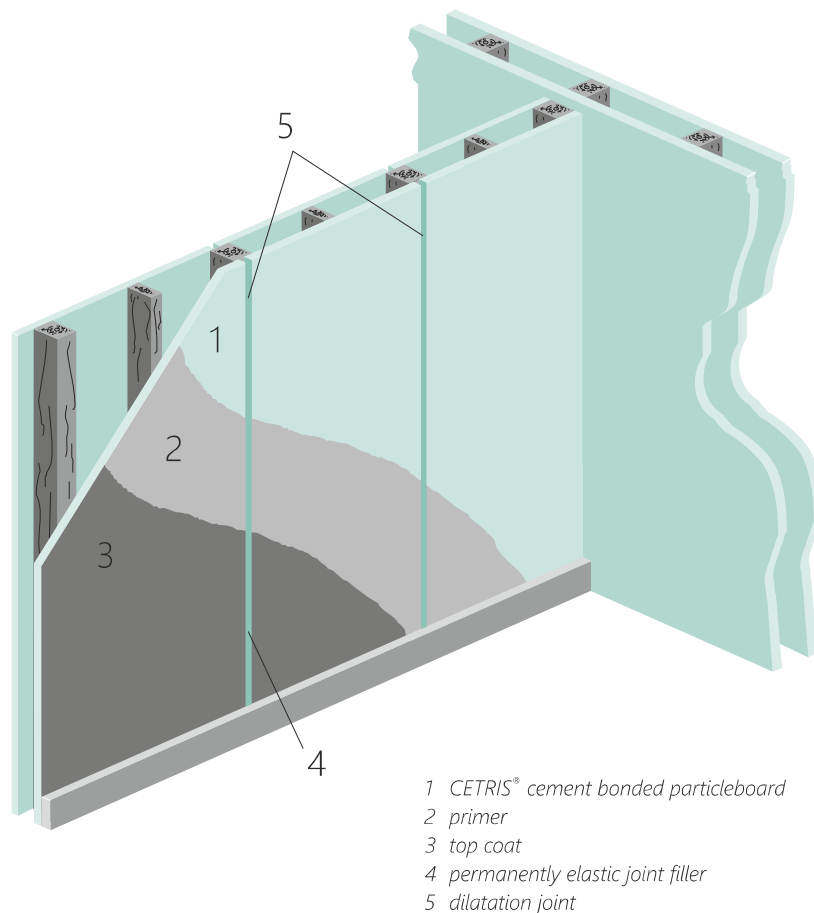

Recommended paints for colour surface finish of CETRIS® boards		
Primer	Top coat	Manufacturer
FORTE Penetral - micro-molecular primer	ETERNAL - universal dispersion coating material	AUSTIS
ACRYL EMULZE - water soluble primer	ACRYL COLOR - water soluble acrylic top coat	JUB
Acrylic-Silicone Primer - water soluble primer	Silicone façade paint or Acrylic façade paint - water soluble façade paint	CEMIX
BTAi top 1000A-CRT - single-component water soluble primer	BTAi top 1000A-CTS - single-component water soluble top coat	BTAindustry
HC-4 - water soluble primer	GAMADEKOR (F, FS, FS1, SIL, SA) - water soluble top coat	STOMIX
EkoPEN - deep primer	koFAS (EkoFAS Extra) - smooth acrylic façade coat	EKOLAK
Quarzgrund - resin-based filled primer	TEX Egalisationsfarbe - water resistant highly permeable façade paint.	TEX COLOR
Sto Prim Concentrat - primer concentrate	Sto Color Royal - matt acrylic based façade paint	STO
Mistral Primer	Mistral Univerzal - water soluble enamel paint	MISTRAL
Ceresit CT 17 - deep primer without solvents	Ceresit CT 44 - acrylate paint	HENKEL
Baumit universal primer - primer for surface absorption levelling	Baumit Nanopor paint - highly resistant vapour resistant paint on silicate basis for exteriors, dirt resistant	BAUMIT
FANO - façade penetration	RENOFAS - fine façade paint	CHEMOLAK
KEIM Silangrund - waterproofing silane-based primer	KEIM Granital - homogenized silicate-based paint	KEIM FARBEN
BILEP P - dispersion acrylic penetration	ETERfix BI - dispersion acrylic matte top coat	BIOPOL PAINTS
Funcosil Hydro-Tiefengrund - water soluble deep penetration	Funcosil Betonacryl - anti-carbon acrylic paint for concrete surfaces	REMMERS
PEN-fix - water soluble off-white penetration	ELASTACRYL SATIN - water soluble matt façade paint	TOLLENS
REMCOLOR Imprégnation - primer	REMCOLOR Roof Paint - water soluble dispersion paint for external use	deREM

Recommended paints for transparent surface finish of CETRIS® boards	
Primer	Manufacturer
IMESTA IW 290 water-resistant silicone-based oil product.	IMESTA
TOLLENS Hydrofuge Incolore hydrophobic solution for stone, masonry, concrete and plaster protection.	TOLLENS
SIKAGARD 700S hydrophobic single-component solution on siloxan resin basis.	SIKA
Herbol-Fassaden-Imprägnierung hydrophob Colorless, solvent impregnation agent for water resistant paints on all mineral bases	HERBOL Akzo Nobel Deco

5.3 Interior Plasters

Plastering creates surface finish with an invisible joint. The CETRIS® boards must first be primed, the joints must be filled with permanently elastic filler. Subsequently a trowel-on coating is applied on the full surface and the glass-fibre bandaging material is embedded in it. After the smoothing layer, the trowel-on material is re-applied and is followed by the final finish. We recommend use of the complete system of one

surface finish manufacturer and observation of the technological procedures of the given manufacturer. The underside of the CETRIS® board must be treated with at least one coating layer (for instance, primer – base coat or coat with higher diffusion resistance) to prevent bending of the board during surface finishing work on the face of the board.

- 1 CETRIS® cement bonded particleboard
- 2 primer
- 3 filling compound
- 4 bandage fabric
- 5 plaster
- 6 dilatation joint
- 7 permanently elastic joint filler

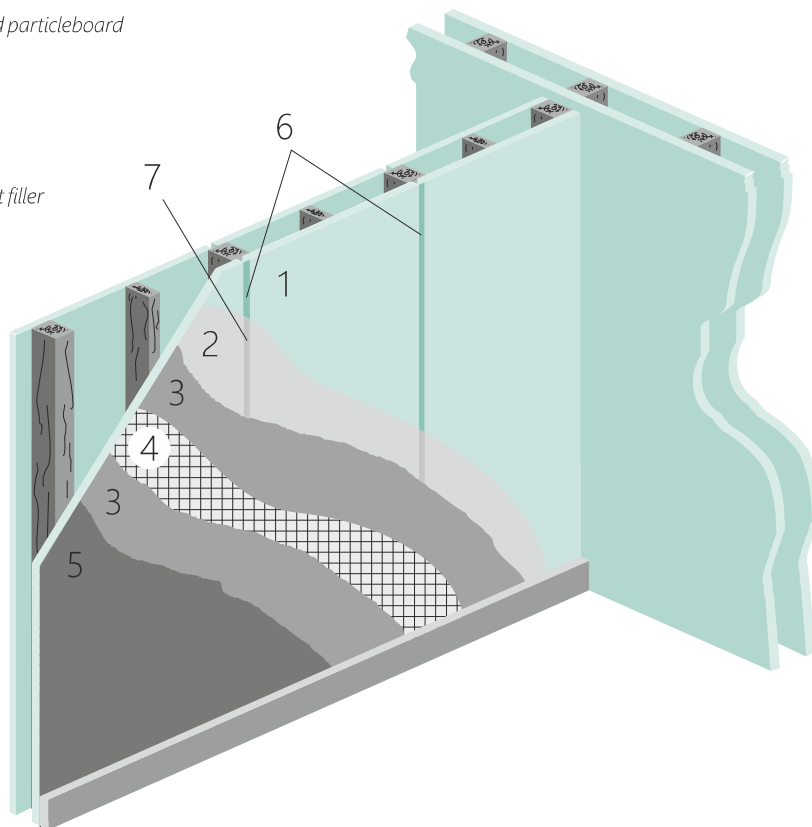

5.4 Exterior Plasters

Application of plasters is surface finishing with an invisible joint. The CETRIS® boards continuously expand and shrink as a result of humidity dilatation movements. To prevent damage of the façade plaster by hair-thin cracks caused by these movements, it is necessary to cover the CETRIS® board with an insulation board (polystyrene, mineral wool) with the minimum thickness of 30 mm. When using a CETRIS® cement bonded particleboard of max. format 1,250 x 1,250 mm, an insulation board thickness of 20 mm suffices. The insulation will create a separation layer to which other layers are applied, like in the case of the contact thermal insulating systems – filling compound, bandage, noble plaster. The CETRIS® boards must be treated with a penetration agent, the joints need not be filled in this case. Polystyrene and mineral wool are glued with cement glue or low-expansion foam to cover the joints between the CETRIS® cement bonded particleboards.

Mechanical anchoring of insulation boards to CETRIS® boards is implemented with disc dowels (self-tapping screw with disc head of high-quality polyethylene). The number of anchoring elements are specified by the manufacturers of the insulation boards, or the manufacturer of the discs shall be minimum 4 pieces/m²

Recommended products for anchoring the insulation:

- EJOT SBH-T 65/25, screw diameter 4.8 mm, anchoring length 20–40 mm. Used in combination with the self-tapping screws EJOT® Climadur-Dabo SW 8 R.
- Subsequently a trowel-on coating is applied on the full surface and the glass-fibre bandaging material is embedded in it. After the smoothing layer, the filling compound is re-applied and is followed by the final finish.

- 1 CETRIS® cement bonded particleboard
- 2 primer
- 3 insulation board
- 4 filling compound
- 5 bandage fabric
- 6 priming
- 7 plaster
- 8 dilatation joint

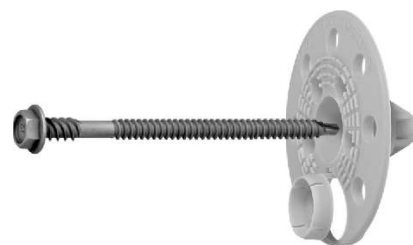
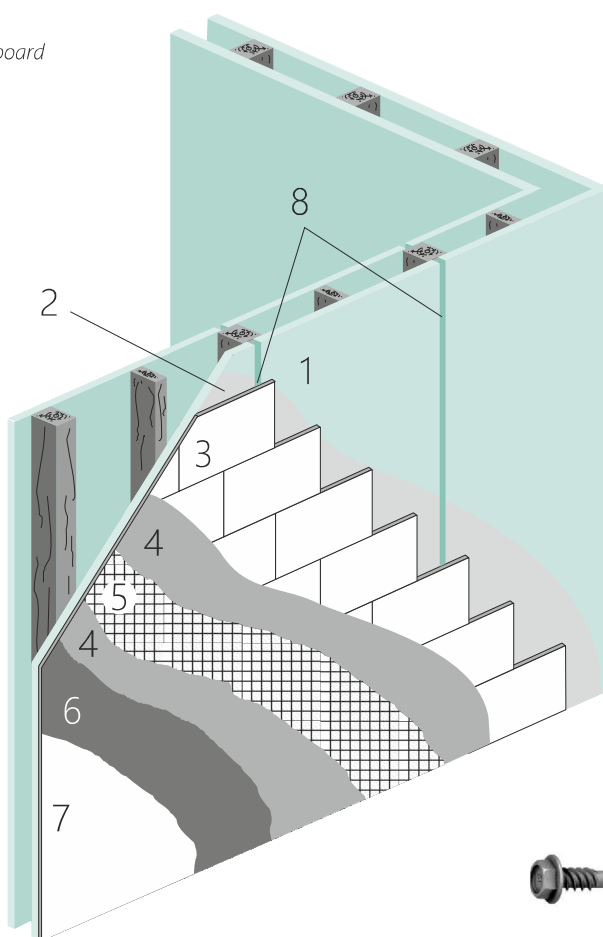

5.5 Interior Ceramic Tiles

Areas under normal stress

When tiling, it is recommended to use permanently elastic fillers for joint filling between CETRIS® cement bonded particleboards, as well as for the tiling itself. The gluing filler must be spread across the whole surface not only in points. The dilatation joints between the boards must be visible either in the tile or glue the tile between the boards only to one CETRIS® board and leave it without gluing filler at the point of overlap of the CETRIS® board joints. This solution is designed for spaces commonly

exposed to water. Maximum tile size 200 x 200 mm. The backside of the CETRIS® board must be treated with at least one coating layer (for instance, primer – base coat or coat with higher diffusion resistance) to prevent bending of the board during surface finishing work on the face of the board. Gluing of tiles can be done only after acclimatization of the CETRIS® boards in the given environment.

- 1 CETRIS® cement bonded particleboard
- 2 priming
- 3 bonding cement
- 4 ceramic wall tiles
- 5 joint filler
- 6 permanently elastic joint filler
- 7 dilatation joint

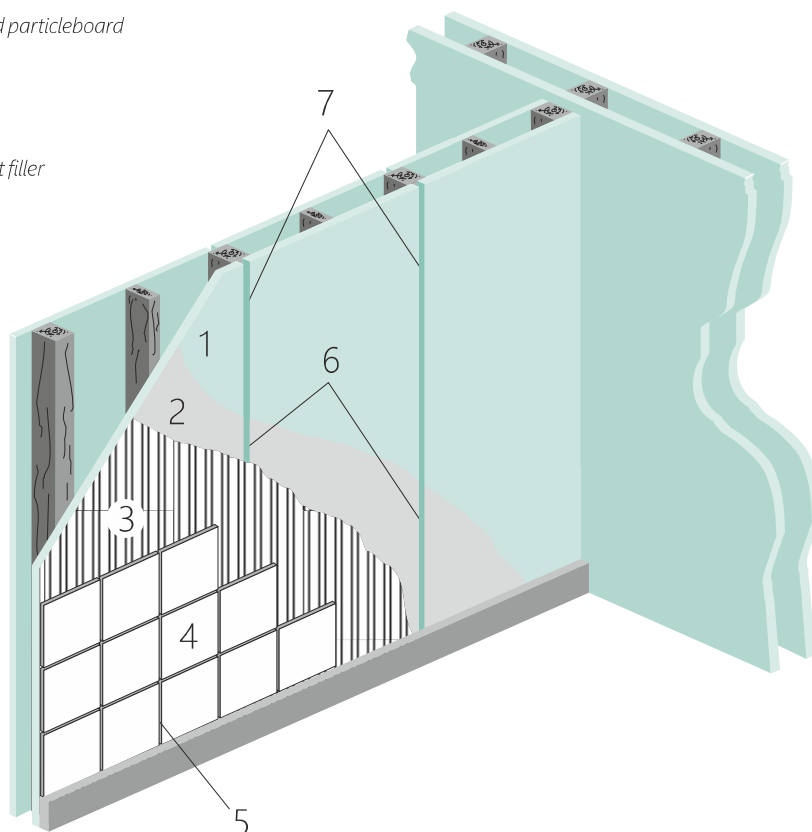

System composition	Primer	Gluing filler	Joint filler (dilatation joint filling)
MAPEI	Not required	Ultramastic III	Ultracolor (Mapesil AC)
SCHÖNOX	Schönox KH, diluted with water in a ratio of 1:3	Schönox PFK, resp. PFK White	Schönox WD Flex (Schönox ES, or Schönox SMP)
BOTAMENT	Botact D11	Botact M21	Motact M32 (Botact S5)
BASF	PCI-Gisogrund	PCI-Nanolight	PCI-Flexfug
CERESIT	Ceresit CT 17	Ceresit CM 16 – lower load Ceresit CM 17 – higher load	Ceresit CE 40 (Ceresit CS 25)
SIKA	not required	Sika Ceram 203	Sika Fuga
CEMIX	Superkontakt 241	FLEX ETRA 045	FLEX 079 nebo BIOFLEX 179

Areas under moisture stress

In non-ventilated sanitary spaces, showers and spaces with increased humidity exposure, CETRIS® cement bonded particleboards must be treated with hydro insulating paint:

- 1 CETRIS® cement bonded particleboard
- 2 priming
- 3 hydro-insulating trowel-on coating
- 4 bonding cement
- 5 ceramic wall tiles
- 6 joint filler
- 7 permanently elastic joint filler
- 8 dilatation joint

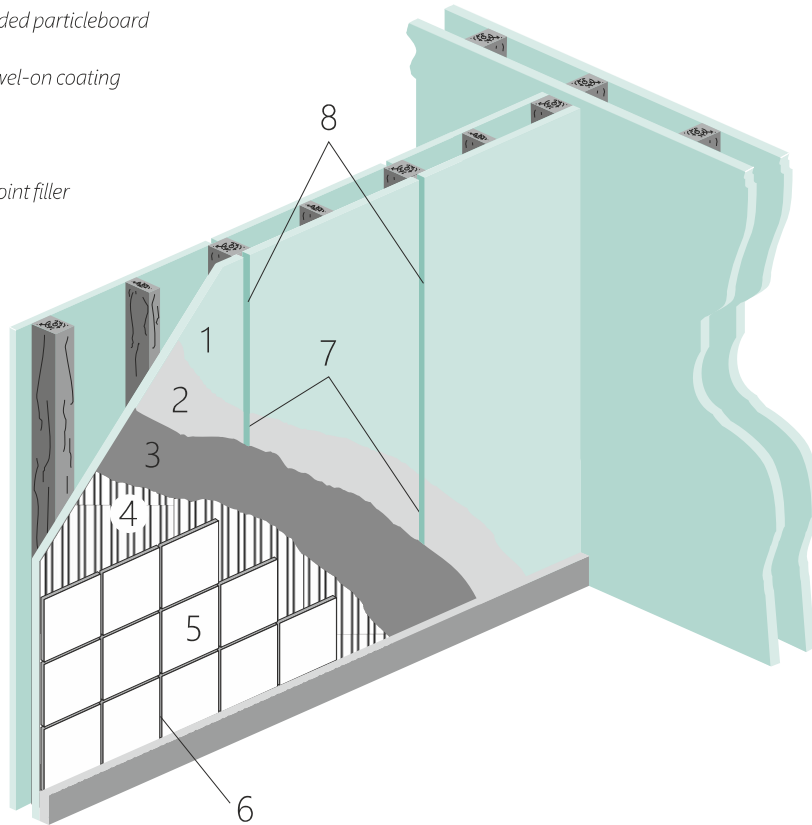

System structure	Primer	Hydro insulation (bandaging of corners, dilatation)	Bonding cement	Joint filler (dilatation filler)
MAPEI	not required	Keralastic tl. 1 mm (MAPEBAND)	Keralastic	Ultracolor (Mapesil AC)
SCHÖNOX	Schönox KH, diluted with water in a ratio of 1:3	Schönox HA (Schönox ST-IC, popř. ST-EA)	Schönox PF, or Schönox Q9	Schönox SU, popř. UF Premium (Schönox ES, or Schönox SMP)
BOTAMENT	Botact D11	Botact DF 9 Plus (AB 78)	Botact M21	Motact M32 (Botact S5)
BASF	PCI-Gisogrund	PCI-Lastogum (PCI-Dichtband Objekt)	PCI-Nandlight	PCI-Flexfug
CERESIT	Ceresit CT 17	Ceresit CL 51 (Ceresit CL 52)	Ceresit CM 16 – lower load Ceresit CM 17 – higher load	Ceresit CE 40 (Ceresit CS 25)
SIKA	not required	Sika Top 109 Elastocem (Sika Tape Seal S)	Sika Ceram 203	Sika Fuga
CEMIX	Superkontakt 241	1K hydro-insulation film (elastic sealing tape 100, inner and outer corner)	FLEX ETRA 045	FLEX 079 nebo BIOFLEX 179